

A-A (5 : 1)

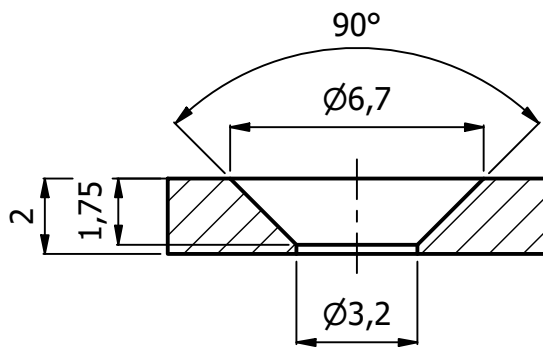

S (N)
↑
N (S)



1:1 scale

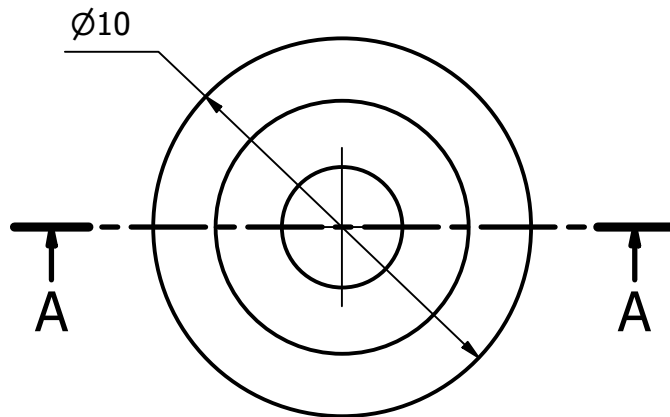

All measures are in millimeters (mm)

Author M.D.	Date 11/11/2019	Type N35	Surface Treatment Nickel coated	Material Neodymium	Measures tolerance: +/- 0.1 mm
			Description Countersink hole magnet - axially magnetized (N+S pole)		
			Code NS01.35NI00.1023	Scale 5 : 1	Format A4
Via F. Comelli 39 33034 Fagagna UD - Tel. 0432 801675					